



# vision

## 90/15 R/F Electronic Tilting Table

### Product Data

#### Movements

Tilting	Motorized, $-15^{\circ}/+90^{\circ}$ Speed $3.2^{\circ}/s$ @ 50 Hz; $3.9^{\circ}/s$ @ 60 Hz Automatic stop at $0^{\circ}$ (horizontal)
Longitudinal table top	Motorized, 1000 mm (600mm head side, 400mm feet side) Speed $31\text{ mm}/s$ @ 50 Hz, $37\text{ mm}/s$ @ 60 Hz Automatic centering
Transversal table top (on request)	Motorized, 200 mm ( $\pm 100\text{ mm}$ ) Speed $65\text{ mm}/s$ Automatic centering
Longitudinal SFD / I.I. / Tube	Servo-assisted and manual, with electromagnetic brake Run-length 550 mm
Transversal SFD / I.I. / Tube	Manual, movement force $< 40\text{ N}$ , with electromagnetic brake Run-length 220 mm
Vertical SFD / I.I. / Tube (compression)	Manual, movement force $< 40\text{ N}$ , with electromagnetic brake Run-length 265 mm
SID – Source to Image Distance	$670 \div 935\text{ mm}$ (might change depending on tube type)
SFD – Table top distance	$195 \div 460\text{ mm}$
SFD – Film distance	69 mm
SFD parking position	Out of X-ray field for undertable bucky exposure
Motorized movement control	Closed loop feedback, position and speed control

#### Table Top

Max patient weight	135 kg
Length	2020 mm
Width	700 mm
Height from ground	895 mm
Surface	Flat
Material	Plastic laminate
Filtration	0.8 mm Al @ 100 kVp, HVL = 2.7 mm Al
Focus to skin distance (under table x-ray source)	405 mm



### Spot Film Device (SFD)

Technology	Microprocessor control
Cassette size	From 18x24 cm to 35x35 cm From 8"x10" to 14"x14"
Film subdivision	1, 2, 3 on one in line; 4, 6 on one in cross. See attached tables
Rapid sequence	Selectable
Fluoroscopy/exposure switching time	0.7 ÷ 1.3 s (depending on cassette size and division)
Delay between two exposures in rapid sequence	0.4 s (average)
Cassettes loading	Front (left) side
Cassettes tray	Autocentering
AEC measuring chamber	Predisposed for installation of solid state or ion chambers
Grid	Vibrating, synchronized to x-ray start Ratio: 10:1 Focalization: 75 cm Lines/cm: 47 Size: 360 x 380 mm
Internal collimation	Electronic with near-film shutters

### Under Table Electronic Collimator

Beam Limitation	Square and rectangular
Number of limitation shutters	6 pairs of shutters, including near-focus
Limitation shutters material	Fe + Pb
Operation	Fully automatic with SID compensation, microprocessor controlled
"Hold" function	The position of diaphragms in fluoro mode can be maintained when the unit is switched into exposure
Minimum internal filtration	0.3 mm Al eq
Leakage radiation	≤45 mR/hr @ 150 kVp, 350 W
Min. size of x-ray field @ SID = 1 m	< 1 cm <sup>2</sup>



### Under Table Potter Bucky (Option)

Cassettes size	From 13x18 cm to 35x43 cm (up to 43x43 cm for portable digital detectors)
Longitudinal movement	Manual, locking by electromagnetic brake – movement force <20 N with table in horizontal position – movement force <30 N with table in vertical position
Range of movement	910 mm
Cassette tray	Manual loading, auto-centering
Size sensing cassette tray	Option
X-ray beam to film centering	With spot light on manual collimator (on column tubestand)
AEC measuring chamber	Predisposed for installation of solid state or ion chambers
Film to table top distance	84 mm
Grid	Vibrating, synchronized to x-ray start Ratio: 10:1 Focalization: 120 cm Lines/cm: 34
Grid start signal	Can be set to: 220 Vac, 120 Vac, 24 Vdc

### Floor Column Tubestand (Option)

Height	2400 mm
Longitudinal movement	Manual, with electromagnetic brakes Run-length 1710 mm standard, 2710 mm with extension rail
Transversal movement	Manual, with electromagnetic brakes Run-length 240 mm with center lock
Vertical movement	Manual, with electromagnetic brakes Run-length 1470 mm
Focus to Floor distance	430 ÷ 1900 mm
Max SID (on bucky)	1120 mm
Column rotation	Manual, with mechanical stops every 90° ± 90°
Tube arm support rotation	Manual with electromagnetic brakes Range ± 180° Angle indication with goniometer
Projections	Undertable Bucky; Off-table; Oblique; Lateral (with optional accessory); On vertical chest stand (option)
Brakes activation	With pushbuttons on tube arm support The pushbuttons have signal lamps
Column-bucky alignment	With light marker



## Over Table Manual Collimator (on Column)

Beam Limitation	Square and rectangular
Number of limitation shutters	4 pairs of shutters, including near-focus
Limitation shutters material	Fe + Pb
Operation	Manual
Field coverage	43 x 43 cm @ SID = 1 m
Total collimator filtration	≥ 0.5 mm Al eq @ 100 kV, HVL = 2.7 mm Al
Leakage radiation	≤ 45mR/hr @ 150 kVp, 350 W
Light source	Halogen bulb, 24 V dc, 100 W

## Functions

Operating mode	<ul style="list-style-type: none"> <li>- Fluoroscopy</li> <li>- Radiography</li> <li>- Digital</li> </ul>
Digital imaging	The unit is predisposed for connection to digital acquisition unit DIVA-D.
Fast bolus chasing	When this function is selected, the movements of tabletop (head direction) and SFD (foot direction) are combined to help chasing the contrast bolus in rapid transit procedures.
Movements locks	With electromagnetic brakes. All brakes are automatically activated when the prep switch is pressed.
Compressor	The compressor is automatically moved into the exposure area when a cross subdivision is selected. A manual modality can also be chosen to override the automatic function

## User Interface

Display	<p>Two lines by twenty characters alphanumeric display with indication of the following information:</p> <ul style="list-style-type: none"> <li>- Tilt angle</li> <li>- Source to Image Distance (SID)</li> <li>- Cassette size</li> <li>- Cassette division</li> <li>- Number of exposures remaining</li> <li>- Operating modes</li> <li>- Warning / error /failure messages</li> </ul>
SFD Control keyboard	<p>A flat and waterproof control keyboard on the SFD allows control of the following functions:</p> <ul style="list-style-type: none"> <li>- Film division program</li> <li>- Rapid sequence</li> <li>- Cassette insertion/ejection</li> <li>- Room light on/off switch</li> <li>- Fast bolus chasing</li> <li>- Collimator functions</li> </ul>



	<ul style="list-style-type: none"> <li>– Compressor functions</li> <li>– Image intensifier and TV chain functions</li> <li>– Automatic/manual KV selection</li> </ul>
Joysticks on SFD control panel	<p>Joysticks on the SFD control panel activate:</p> <ul style="list-style-type: none"> <li>– the motorized and servo-assisted movements</li> <li>– exposure and fluoroscopy switch</li> </ul>
Tablesides keypad	<p>An additional flat and waterproof keypad is mounted on the front cover of the table to allow convenient operation of the movements in all positions of the table. The available controls are:</p> <ul style="list-style-type: none"> <li>– Tabletop movement (4 ways)</li> <li>– Tilting (vertical - Trendelenburg)</li> </ul>

### Safety Features

Single fault safety	A dedicated microprocessor continuously checks the operation of the equipment to inhibit unwanted movements in case of single component failure.
Movements safeties	All movements have "dead man" operation
Anticollision safeties	The movements are software controlled to prevent collision of any part of the equipment to floor, ceiling and walls. Room dimensions can be set during the installation.
Self test	The unit performs a complete test at power on

### Accessories

2 hand grips	Standard, continuous adjustment
Shoulder support	Standard, continuous adjustment
Foot rest	Standard, with stops every 100 mm
Compression band	Option, continuous adjustment
Gynaecological leg support	Option, continuous adjustment
Lateral cassette support	Option (to be used only with optional tubestand)



### Electrical Features

Standard power supply voltage	<ul style="list-style-type: none"> <li>- Three phase 380-400 Vac <math>\pm</math> 10% (standard)</li> <li>- 208/220/415/480 Vac <math>\pm</math> 10% with optional external auto-transformer (on request)</li> </ul>	
Frequency	50/60 Hz	
Absorbed current	6.5A @ 208 Vac $\pm$ 10% 3.5A @ 380-400 Vac $\pm$ 10% 3A @ 480 Vac $\pm$ 10%	6A @ 220 Vac $\pm$ 10% 3.5A @ 415 Vac $\pm$ 10%
Absorbed power	2.5 kVA	
Equipment type and classification according to IEC 60601-1	Class I with type B applied parts	
Degree of protection according to IEC 60529	IP00	
Operating mode	Continuous	

### Mechanical Features

Weight	1030 kg
Serial changer	Over table
X-ray tube and collimator	Under table

### Environmental Conditions

Operating conditions	Temperature:	+10° to +40° Celsius
	Humidity:	30% to 75% non condensing
	Pressure:	700 to 1060 hPa
Conditions for transport and storage	Temperature:	-20° to +70° Celsius
	Humidity:	up to 95 % non condensing
	Pressure:	> 630 hPa

### Standards and Regulations

	FDA approval grants the product compliance to USA Standards. NOT for version with column tubestand
---	--





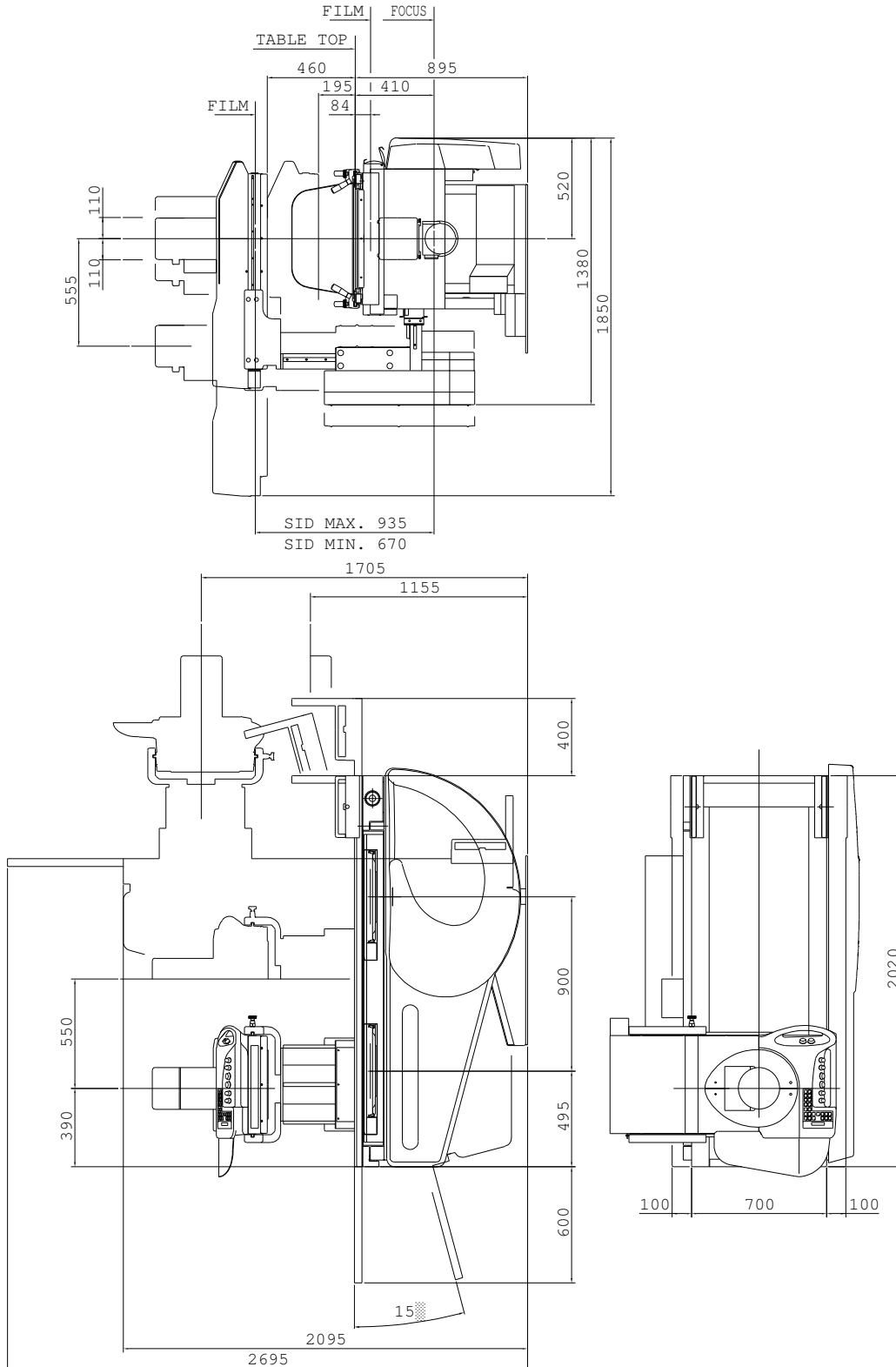













## Dimensions (all quotes in mm)





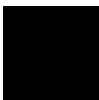











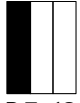
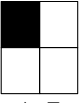
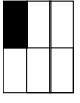

### Cassette division for cm size cassettes

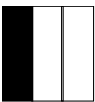
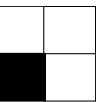
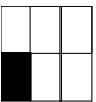
18 x 24 cm		 9x24		 9x12	
24 x 18 cm		 12x18			
24 x 30 cm		 12x30			
30 x 24 cm		 15x24	 10x24	 15x12	 10x12
30 x 30 cm		 15x30	 10x30		
35 x 35 cm		 17x35	 12x35		



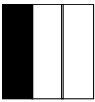

### Cassette division for inch size cassettes

8" x 10"		 4x10	 2.5x10	 4x5	 2.5x5
10" x 8"		 5x8			
9.5" x 9.5"		 4.7x9.5	 3.2x9.5	 4.7x4.7	 3.2x4.7
10" x 12"		 5x12			
12" x 10"		 6x10	 4x10		
14" x 14"		 7x14	 5x14		

**Note:** Products are continuously under review in the light of technical advancement. The actual specification may therefore be subject to improvement or modification without notice.

VILLA SISTEMI MEDICALI s.p.a.  
20090 BUCCINASCO (MI) - ITALY,  
Via delle Azalee, 3  
Tel. +39-02-488591, Fax +39-02-4881844

Company with Quality System certified by



ISO 9001:2015



ISO 13485:2016